



Microchannel for HVAC/R

**ThermoKey®**  
Heat Exchange Solutions





*In the next 5 years aluminium microchannel cores will replace 50% of the copper coils for HVAC/R application. We are ready to take on the role of key player.*

Giuseppe Visentini — Executive Board Member — COO, ThermoKey Spa



## European Leader

---

ThermoKey has been producing heat exchangers since 1991. Since then it has gained a key player role, becoming partner to the major chiller manufacturers in the European Market.

**TKMicro  
is the best solution for HVAC/R.**

# What the market asks for

## Knowledge

---

Our customers must compete to meet the always more and more sophisticated needs of the market. The challenge is on knowledge: metallurgic, thermodynamic, mechanic, acoustic and electronic. Our customers have to be able to count on a partner capable of answering with knowledge to the new challenges.

## Innovation

---

Innovation is the central issue in economic prosperity (Porter). In the HVAC/R market this means manufacture known products in an innovative way and new products and services.

The most appreciated goals by the market are those which lead to the reduction of waste for the entire life of the product.

## Reliability

---

Reliable Companies that respect sales contracts and whose products are in accordance with their use function throughout time.

## Saving

---

A quick come back of the initial investment is the key in the Service market and to win competition against products of the low range. However saving is also the reduction in the use of the natural resources of the planet.

# ThermoKey answers

## European knowledge leader

---

Since 2009 ThermoKey has been investing in microchannel technology and it has developed its own know-how by working together with its qualified supply chain and with the best pioneer customers in order to learn how to manage the manufacturing process of its products.

## Cutting-edge technology

---

ThermoKey has invested to offer a solution studied especially for the HVAC/R market starting from an automotive technology. The result is an heat exchanger which, with its innovative characteristics of lightness and thickness, can deeply change the actual offer available to our customers.

## Long lasting products

---

TKMicro is installed on thousands of units which work efficiently. Materials, thicknesses and the manufacturing process have been especially defined to be the best solution on the market. The durability and the constant performance in time contribute to the quick come back of the initial investment.

## Eco-sustainability and efficiency

---

TKMicro is composed of 100% recyclable materials. Compared to tube and fin technology TKMicro weighs almost 60% less (compact foot-print and weight) and needs much less refrigerant. Its geometry drastically reduces pressure drops leading to energy saving and reduction of the acoustic impact.



## Values

### **THERMOKEY MICROCHANNEL IS DIFFERENT**

- Unique cores optimized for HVAC and refrigeration markets.
- Unique high-quality condensing cores which can reach up to 6 meter length.
- Unique cores designed to allow energy saving (45% saving by reducing pressure drops).

### **100% CUSTOMIZED ALLOYS DESIGNED FOR MAXIMUM PERFORMANCE**

ThermoKey engineers have optimized the design of all the geometrical details of the 100% alloy cores in order to ensure the best compromise between thermodynamics performance, pressure drop and lightness. These features make ThermoKey cores the most efficient in the market.

### THERMOKEY MICROCHANNEL TECHNOLOGY

- The highest resistance of aluminium LLA (Long Life Alloy) to corrosion (SWAAT Test over 80 days in accordance with the ASTM G85-02 norm) ensures reliability and performance.
- Thickness and configuration, unique on the market, make it more resistant to vibrations, water hammer and corrosive environments.
- The peculiar header shape reduces pressure drops on the refrigerant side and allows the use of a single circuit.
- Suitable to all standard refrigerants (R410A, R134a, R22, R407C, R404A, R290, R507A, R245fa ect..).
- The low pressure drops of TKMicro cores available in every size (up to 6 meters) allow to satisfy the needs of high-performance chiller manufacturers.
- Easy cleaning and maintenance.
- In case of need ThermoKey can provide a kit for a quick and easy repair to be used directly on site.

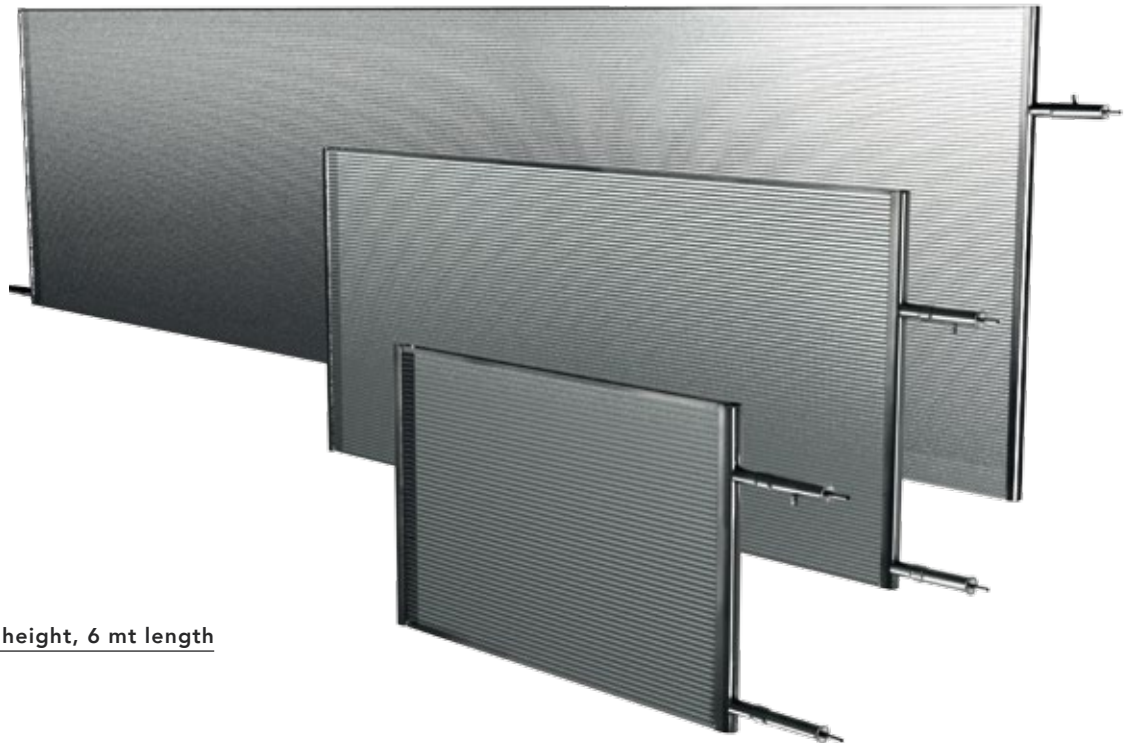

Maximum dimension 1,3 mt height, 6 mt length

# TKMicro

## comparison with round-tube technology

### More efficiency

In comparison to the top quality 4 rows round tube coil, TKMicro offers great advantages in terms of performance.

#### DOUBLE VERSION, SAME RELIABILITY

TKMicro has been designed in two versions: 32mm MPE and the new 25mm MPE which maintains same top quality.

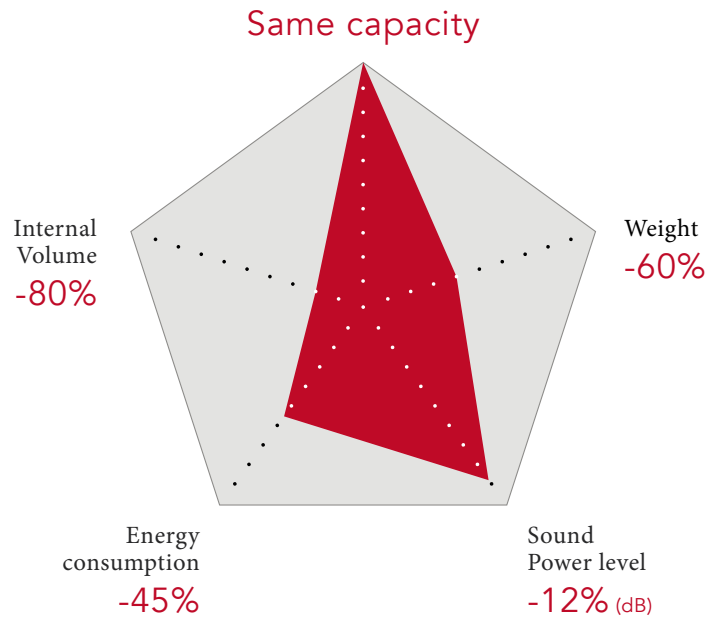

#### PRECONDITIONS

Face Area (H x L)	1.200mm x 2.000mm
Air Flow	25.000 m <sup>3</sup> /h
Delta Temperature	15°C

- TKMicro
- Round Tube Cu/Al

## More reliability

Constant performance over time even in the most aggressive environments.  
Comparison between round tube technology and TKMicro.

### TKMICRO GUARANTEES CONSTANTS PERFORMANCES THROUGHOUT TIME

The accurate choice of the materials supplied by the best manufacturers, the control over the manufacturing process and the attention given to every single detail make TKMicro the most reliable core on the market.

TKMicro has brilliantly performed in the SWAAT Test (ASTM G85-02 norm) resisting over 80 days.

*Results certified by 2 independent laboratories obtaining the same results of a traditional coil (CU/AL).*

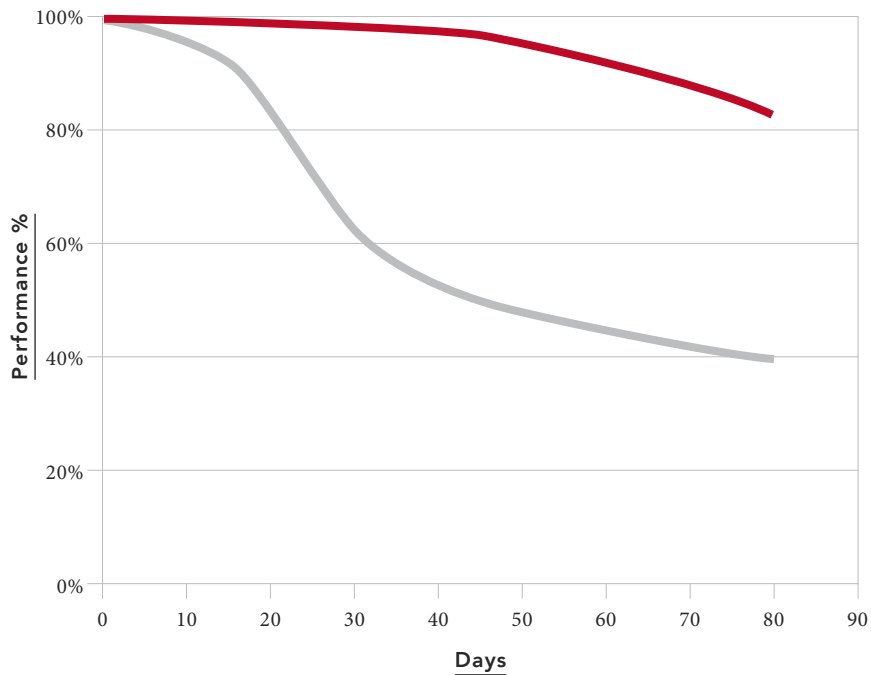

### SWAAT TEST

80 days ASTM G85 - 02 norm  
(laboratory certified data).

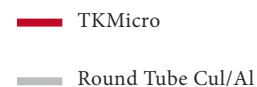

# TKMicro technology

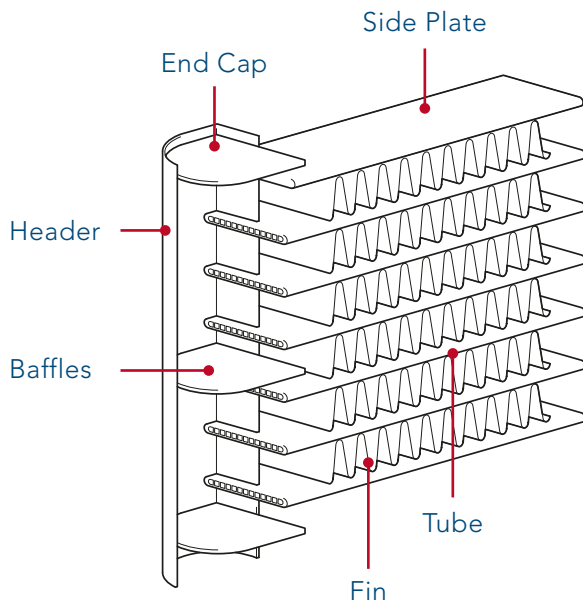

## THERMOKEY MICROCHANNEL TECHNOLOGY

ThermoKey has chosen the top class materials available to ensure the maximum quality for its TKMicro technology.

All core details are developed together with the best supplier on the market in order to answer to the specific requirements of HVAC/R market.

## MULTI PORT EXTRUDED (MPE)

MPE tubes allow the best heat transfer with the minimum dimensions. We provide two different types of MPE tubes to better fit the need of our customers.

Both tubes have the greatest wall thickness on the market (0,5 mm) in order to ensure robustness and corrosion resistance.

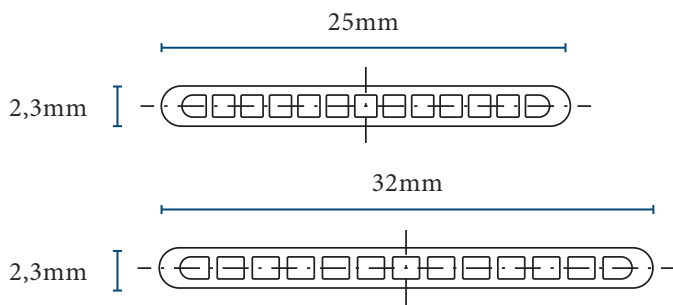

### **TKMicro25: 25mm width**

The best compromise between performance and lightness.

### **TKMicro32: 32mm width**

Ideal to the low pressure drop and the maximum heat transfer. Particularly suitable for application with high air flow rate.

## FIN

Using Finite Element Analysis (FEA) technique and our Wind Tunnel facility, we have optimized louvered angles, fin pitch and the number of louvers in order to achieve minimum air side pressure drop and, at the same time, maximize the air heat transfer.

We produce fins that fit both the 32mm tube and the 25mm tube.

The brazing process ensures a perfect and permanent contact between tubes and fins.

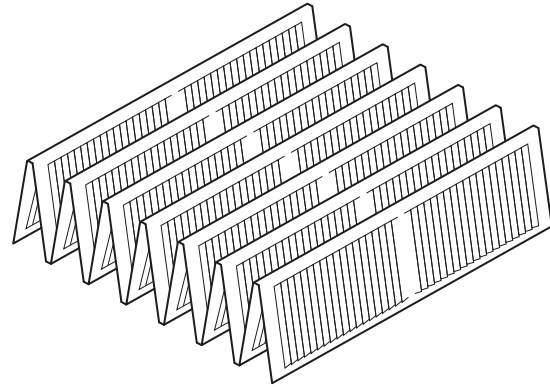

## HEADER

### D-shape header

- For its most demanding customers ThermoKey also provides the D-shape header with 3mm wall thickness. The D-shape has lower pressure drops and is specifically designed for chiller manufacturers.
- Best distribution of refrigerant inside the core.
- Lower pressure drops.
- Best performance of the core.

Upon request, we are also able to provide headers expressly developed to meet the demands of UL Certification.

### Round header

The round header with 2,3mm wall thickness is the best selling header on the market and it is particularly suitable for R410A applications thanks to its excellent pressure resistance.

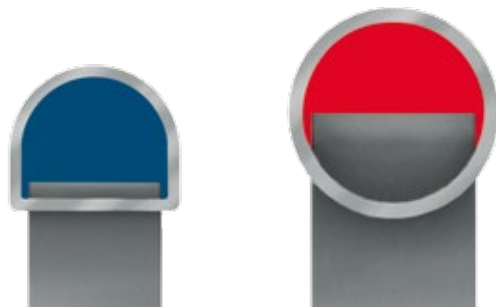
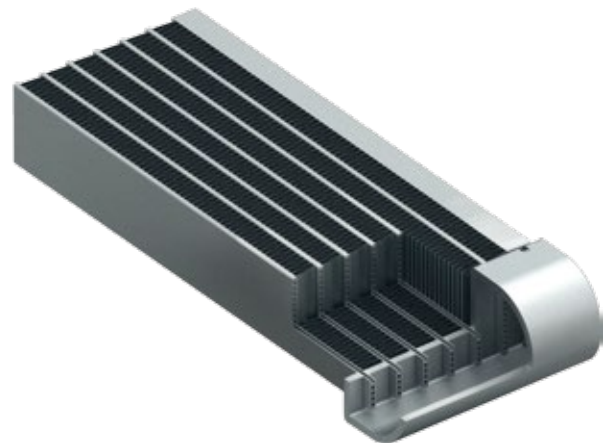

## Efficiency in the production line

Our semi-continuous line is manufactured to fit a wide range of dimensions: we can manufacture cores with length from 400mm to 5800mm and height from 300mm to 1300mm.

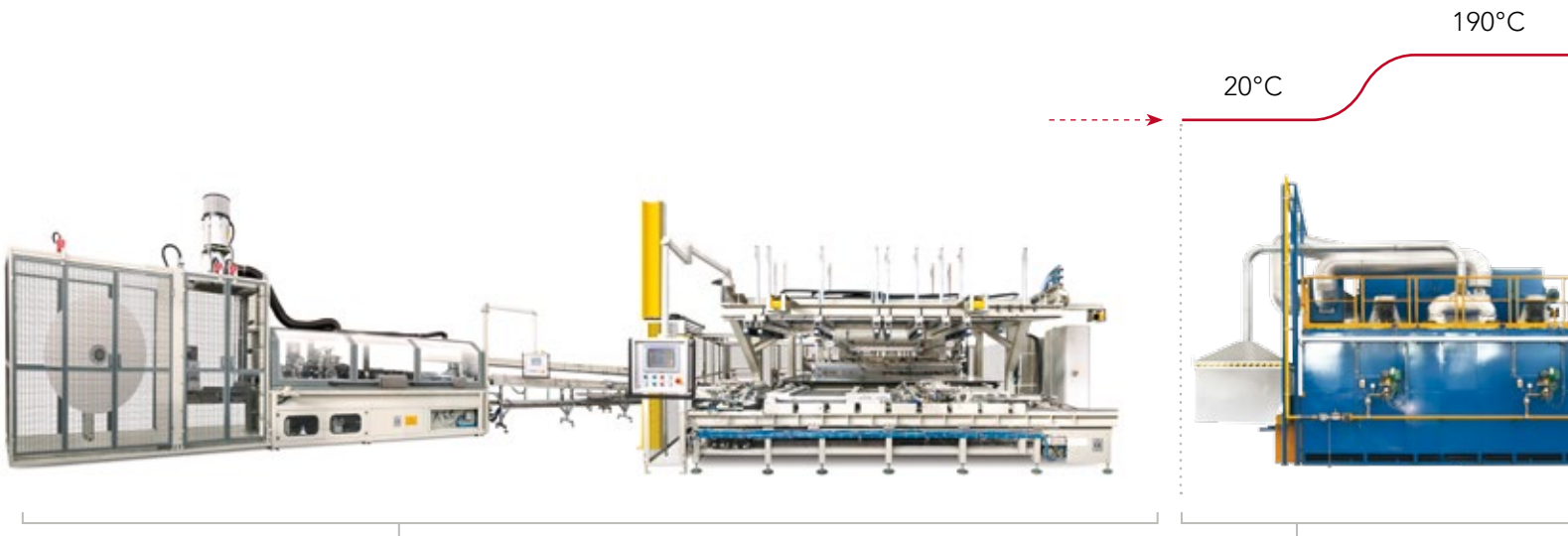

### CORE BUILDER

The microchannel core is built assembling tubes and fins coming from rolled coils.  
Capability to produce in the same line 32mm and 25mm MPE cores.

### THERMODEGREASER

Removal of all residues of oil and other impurities from the cores.  
Before being released into the atmosphere, the oil fumes are further heated up to 550° C in the maximum respect of environmental laws.

## ThermoKey has chosen the last generation of Controlled Atmosphere Brazing (CAB) Furnace for the manufacturing of its aluminium heat exchanger.

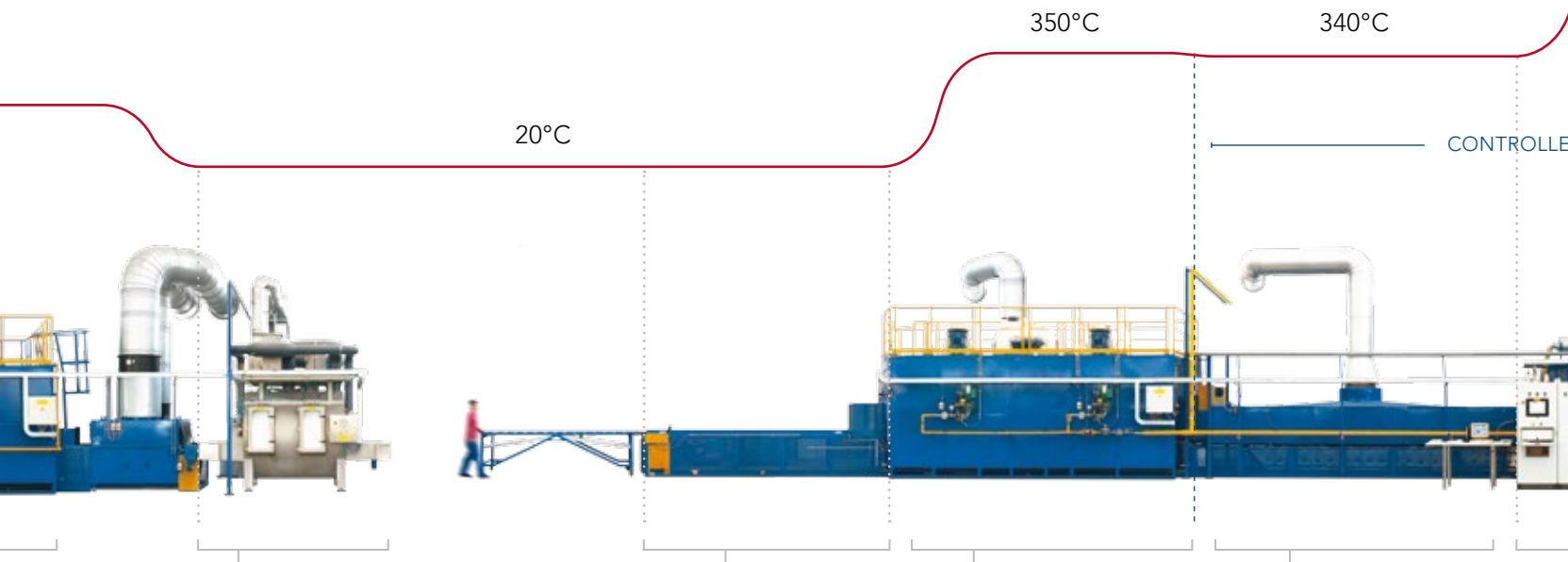

### FLUXER

(only for non pre-fluxed tubes).

Ensure a uniform distribution of the flux on the core, an air knife removes the excess of flux.

### PRE-BRAZING

The operators perform quality checks and apply the AL/Si brazing paste in the junction between header and tubes to ensure a perfect brazing.

Application of the connections in respect to customer requirements.

### DRYER

Evaporate the residual moisture and the binder in order to activate the flux on the tubes.

Two zones of sensors for better process control.

### PRE-HEATING

First heating stage with nitrogen controlled atmosphere. Divide the brazing section from the outside for process stability.

To improve efficiency, recover heat and nitrogen from the main brazing chamber.

The fully automated furnace is provided with an array of sensors distributed all over the line to guarantee control and stability of the brazing process.

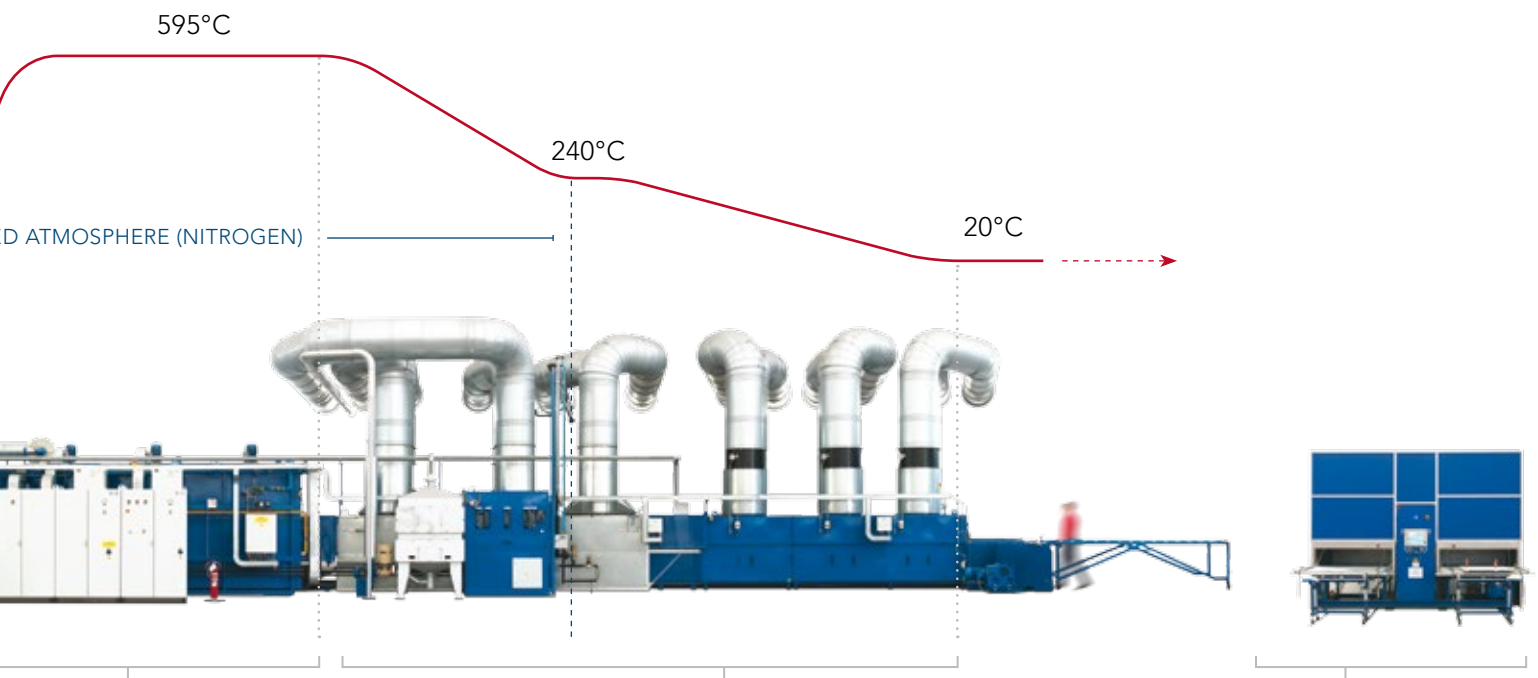

### BRAZING

Here is where the brazing process takes place.  
The metal melts to create uniform and stable junctions.  
Equipped with 3 control zones with 9 thermocouples + 1 for safety.  
6 meters length brazing chamber.  
Temperature uniformity: +/- 2°C.  
Continuous check of oxygen level inside the chamber.

### COOLING

First stage of cooling in a controlled atmosphere.  
It prevents the formation of the oxide on the cores for a longer life time.  
Uniform and controlled cooling  
Final Cooling: forced air cooling down to ambient temperature.

### LEAKAGE TEST

The cores less than 2,5 meter long are tested with helium leak-test machine, while cores up to 2,5 meter long are tested in water tanks.  
pressure test of 50 bars.  
100% of cores are controlled.

# ThermoKey Know-How

## Environment safety of all the process

---

The line is provided with a scrubber for the filtering of the hydrofluoric acid.

## 10,000 m2 production site

---

Totally dedicated to aluminium on an overall settlement of 16,700 m2

## State-of-the-art production process

---

It can produce a 4 meter core every 7 minutes.

## 5 years of lab and field testing

---

Testing performances with different refrigerants, different surface treatments and at different working conditions.



# How to use TKMicro for HVAC/R



## HORIZONTAL MODE

Standard series.

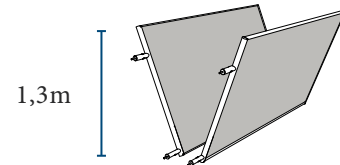

## VERTICAL MODE

Maximum modularity.

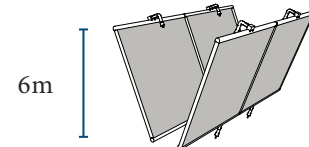

## FREE COOLING APPLICATION

Standard round tube coil+ TKMicro.

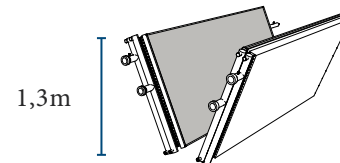

## MULTIPLE HORIZONTAL MODE

Maximum performance with the minimum foot-print.

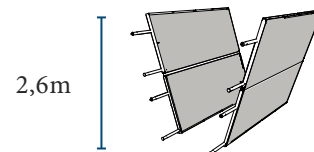

## UPSIDEDOWN "M" SHAPE

Specific for R134a chiller manufacturers.

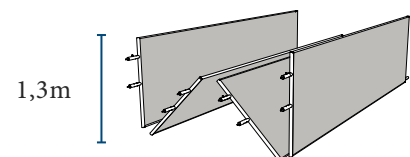

# TKMicro

## Research and development

ThermoKey is constantly involved in an ongoing activity to develop new products and solutions.

Every detail is studied to optimize performances.

To guarantee always the best quality our engineers are working on several aspects:

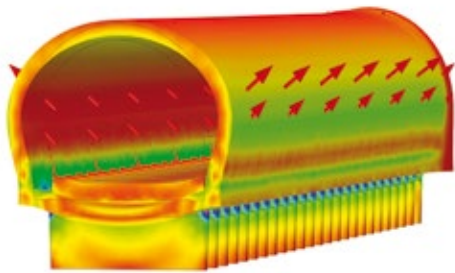

### STRUCTURAL CALCULATION

Through FEM analysis we are able to foresee material deformations and work on possible problems before these occur.

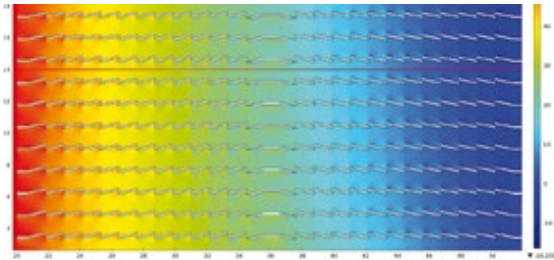

### AIR-FLOW SIMULATIONS

The air flow performance of the TKMicro cores is tested through an especially built Wind Tunnel which is able to reach 22,000m<sup>3</sup>/h.

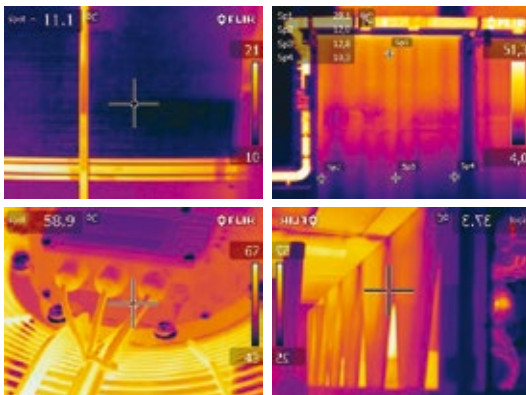

### THERMO-FLUID-DYNAMIC ANALYSES

The thermodynamic performance is maybe the most important information for our customers.

To obtain always more reliable data we realize CFD simulations of the fluid distribution inside the heat exchanger and we constantly verify the accuracy.



## Microchannel Remote Condensers

Thanks to a consolidated know-how in the heat exchanger production, ThermoKey is able to maximize the competitive advantages of microchannel technology, offering a series of remote condensers.

- +30% capacity vs same foot-print traditional condensers.
- Modular design, 1-8 fans.
- Reduced dimensions and weight.



### TABLE REMOTE CONDENSER

#### Performance range

capacity from 10 kW to 480 kW(\*)

#### Fans

diameter Ø 300, 400, 450, 500, 630, 800, 900 mm,  
AC or EC motor



### V-TYPE REMOTE CONDENSER

#### Performance range

capacity from 90 kW to 870 kW (\*)

#### Fans

diameter Ø 800, 900 mm, AC or EC motor

(\*) **Standard conditions** - R404A, condensing temp: 40°C,  
subcooling: 3°K, desuperheat: 25°K, air temp: 25°C

## MICROCHANNEL REMOTE CONDENSER ACCESSORIES

- Wiring + Main switch **W[I]**.
- Monophase/Triphase cut speed controller **“R”**.
- Special Monophase/Triphase cut speed controller **“P”**.
- 3 pole / 6 pole repair switch **“I”**.
- Special treatments for core or casing.

## SPECIALLY DESIGNED ACCESSORIES FOR EC FANS

- EC Controller **“J”**.
- Wiring + Main switch **W[E.I]**.
- Main switch + controller **“Nano” W[En.I]**.
- Main switch + controller **“Basic” W[Eb.I]**.
- Main switch + controller **“Plus” W[Ep.I]**.
- Main switch + controller **“EC Manager” W[Em]**.

## Cardano selection software

It finds the best remote condenser solution with microchannel cores (range from 10kW to 870kW).

The software is constantly internally developed and it is the result of ThermoKey's experience in the thermodynamic calculation of microchannel remote condensers.

### TKCARDANO SELECTS THE UNITS ACCORDING TO THE SELECTED PARAMETERS:

- the main refrigerants on the market;
- the possibility to calculate the thermic performances changing the condensing, subcooling and desuperheat temperatures;
- the possibility to modify altitude, humidity and the inlet temperature;
- the wide range of accessories.



Direction

**Acrobatik.it**

—

Photography

Cover: **Matteo Lavazza Seranto**

3° Cover, p.6-12-21: **Emiliano Lucchetta - Acrobatik**

—

Printed in Italy by

**Primeoffset**

—

TKM0914EN

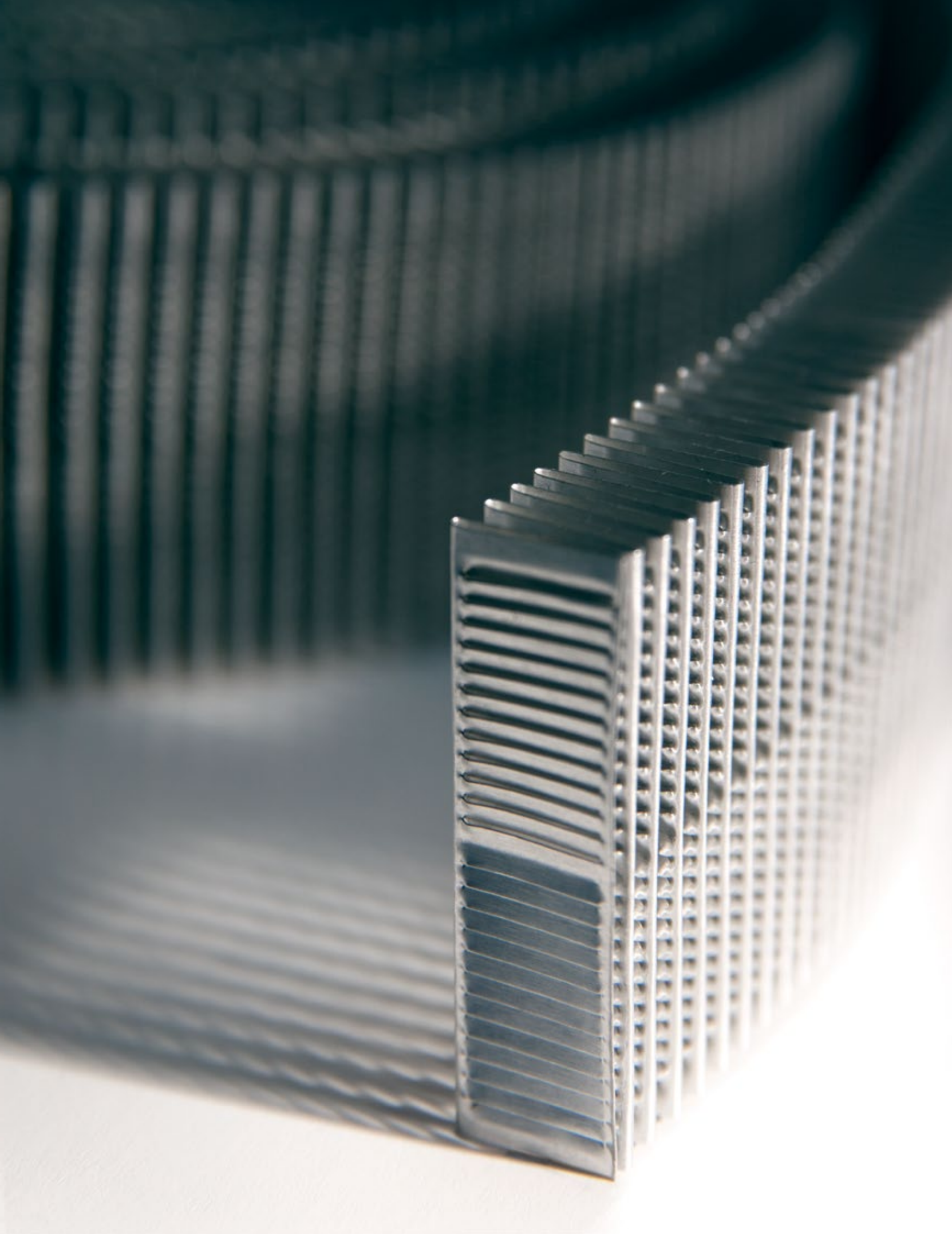

**ThermoKey®**  
Heat Exchange Solutions

**ThermoKey Spa**  
via dell'Industria, 1 - 33050  
Rivarotta di Rivignano Teor (UD) - Italy

**T.** +39 0432 772300  
**F.** +39 0432 779734  
info@thermokey.it  
www.thermokey.it

